

# INSTALLATION INSTRUCTION

1727 BZ/1727 SL

## SAFETY INFORMATION/CONSIGNES DE SÉCURITÉ/INFORMACIÓN DE SEGURIDAD

Please read and understand this entire manual before attempting to assemble, operate or install the product.  
Assurez-vous de lire et de comprendre l'intégralité du présent manuel avant de tenter d'assembler, d'utiliser ou d'installer l'article.  
Lea y comprenda completamente este manual antes de intentar ensamblar, usar o instalar el producto.

### WARNING/ AVERTISSEMENT/ ADVERTENCIA

- Consult a qualified electrician if you are not certain about the installation process. Always install wiring connections in accordance with local code, ordinances and the National Electric Code./Faites appel à un électricien qualifié si vous n'êtes pas certain de la marche à suivre pour l'installation. Effectuez toutes les connexions du câblage conformément au code du bâtiment et aux règlements locaux, ainsi qu'au Code national de l'électricité./Si no está seguro de cómo instalar el producto, consulte a un electricista calificado. Instale siempre las conexiones del cableado de conformidad con los códigos y las ordenanzas locales, y el Código Eléctrico Nacional.
- Changes or modifications to this unit not expressly approved by the party responsible for compliance could void the user's authority to operate the equipment./Les modifications non autorisées expressément par la partie responsable de la conformité peuvent annuler le droit de l'utilisateur de se servir de cet appareil./Los cambios o modificaciones a esta unidad no aprobados expresamente por la parte responsable del cumplimiento podrían anular la autoridad del usuario para operar el equipo.
- Do not attempt to install this product while it is plugged in./Ne tentez pas d'installer le luminaire lorsqu'il est branché./No intente instalar cuando está enchufada.
- Do not connect this light fixture to a dimmer switch or timer./Ne reliez pas ce luminaire à un gradateur ni à une minuterie./No conecte esta lámpara a un regulador de intensidad o temporizador.

## PREPARATION/PRÉPARATION/PREPARACIÓN

Before beginning assembly of product, make sure all parts are present. Compare parts with package contents list and hardware contents list. If any part is missing or damaged, do not attempt to assemble the product.

Avant de commencer à assembler ou à installer le luminaire, assurez-vous d'avoir toutes les pièces. Comparez le contenu de l'emballage avec la liste des pièces et celle de la quincaillerie incluse. S'il y a des pièces manquantes ou endommagées, ne tentez pas d'assembler, d'installer ni d'utiliser le luminaire.

Antes de comenzar a ensamblar o instalar la lámpara, asegúrese de tener todas las piezas. Compare las piezas con la lista del contenido del paquete y la lista de aditamentos. No intente ensamblar, instalar ni usar la lámpara si falta alguna pieza o si estas están dañadas.

**Estimated Assembly Time: 20 minutes**

**Temps d'assemblage approximatif : 20 minutes**

**Tiempo estimado de ensamblaje: 20 minutos**

**TOOLS REQUIRED (NOT INCLUDED)/OUTILS NÉCESSAIRES (NON INCLUS)/HERRAMIENTAS NECESARIAS (NO SE INCLUYEN)**

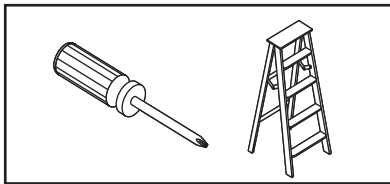

## HARDWARE CONTENTS/QUINCAILLERIE INCLUSE/ADITAMENTOS

**Note:** Hardware shown actual size./**Remarque:** La quincaillerie est illustrée en grandeur réelle./**Nota:** los aditamentos se muestran en tamaño real.

AA

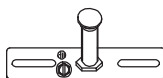

x 1

BB



x 2

CC



x 2

DD



x 2

## INSTALLATION OVERVIEW/VUE D'ENSEMBLE DE L'INSTALLATION/DESCRIPCIÓN GENERAL DE LA INSTALACIÓN

---

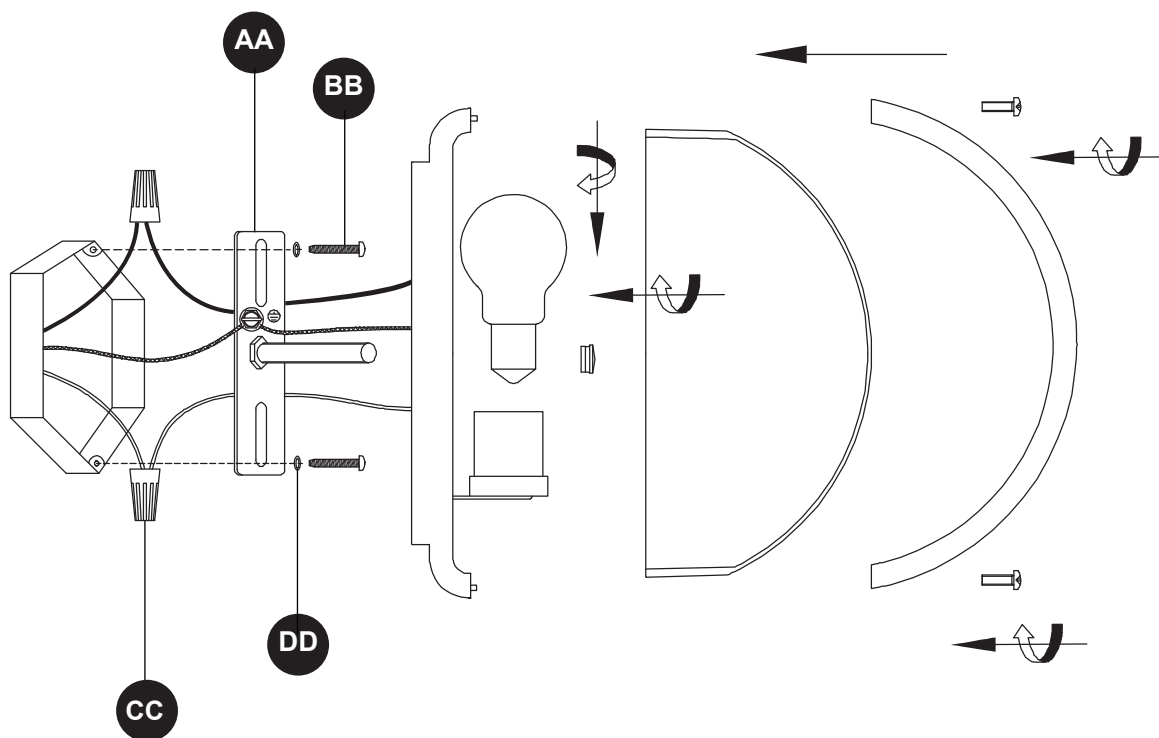

1. Shut off the power at the circuit breaker.
2. Carefully unpack your new fixture and lay out all the parts on a clear area. Be careful not to lose any small parts necessary for installation.
3. Detach the lamp shade and frame from the fixture by unscrewing the screws pre-assembled in the fixture.
4. Secure the mounting back plate (AA) to the junction box using the screws (BB) and washers (DD). The side of the mounting back plate marked "GND" must face out.
5. Connect the ground wire from the fixture and the bare ground wire from the junction box to the ground screw on the mounting back plate (AA). Connect the white wire from the junction box to the white wire from the fixture by twisting a wire nut (CC) onto the bare ends of the wires. Connect the black wire from the junction box to the black wire from the fixture by twisting another wire nut (CC) onto the bare ends of the wires. Make sure wire connections are secure.
6. Carefully place the wires into the junction box. Then install the bulb(not included).
7. Secure the fixture by screwing the removed nut.
8. Install the lamp shade and frame by using the screws removed in step 3.
9. Apply silicone caulking adhesive (not included) completely around the perimeter of the fixture where the back meets the mounting surface to prevent water from seeping into the junction box.